

OPTIONAL

DESCRIZIONE	SOSTITUISCE	DATA
-3		
-2		

code Machine .4 / 5	denomination WIRING DIAGRAMM	Codice 82178
re-examined date 05/04/18	Inspected by date	n°/file mod
validated by date/date	Dishwashers total blatt 5 N° blatt 1 Next blatt -2	82178 --

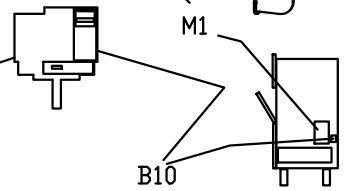
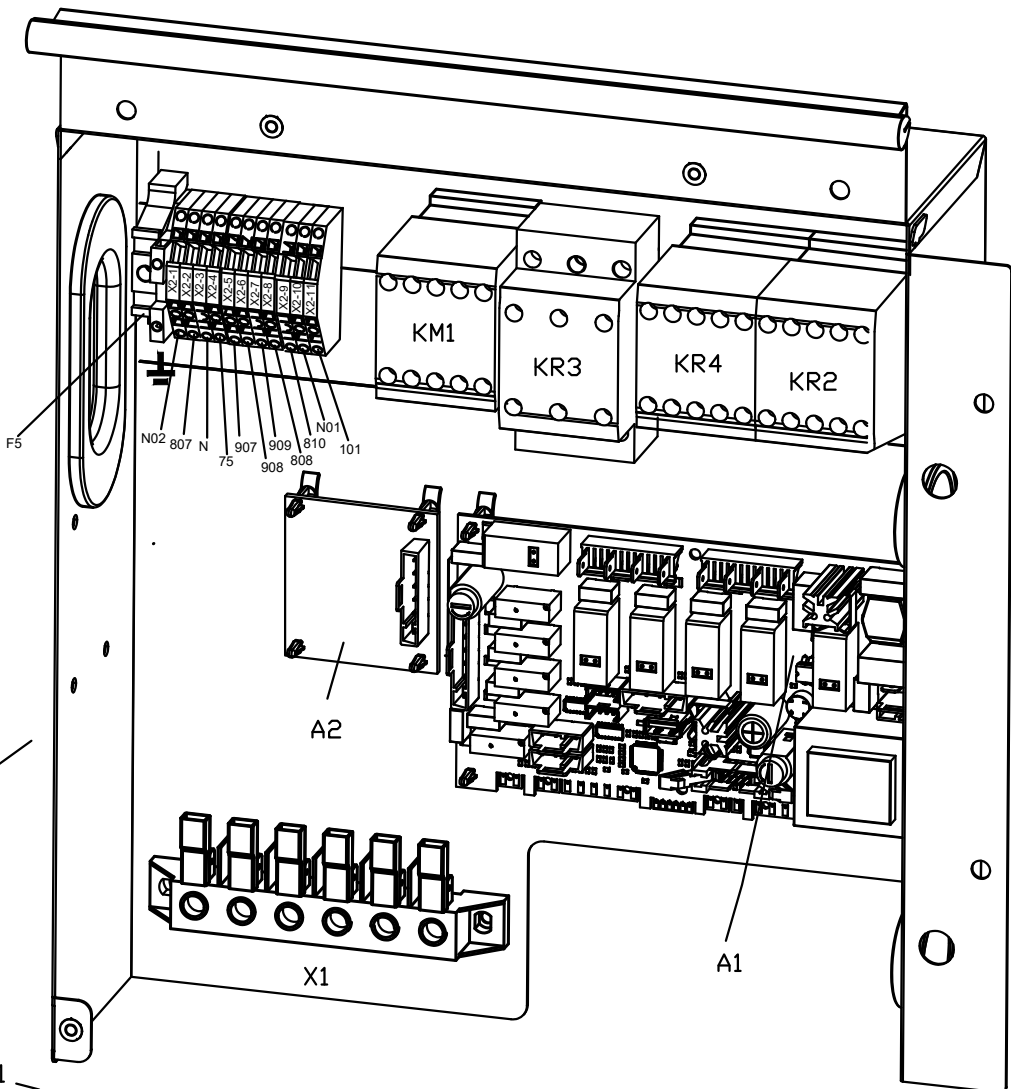
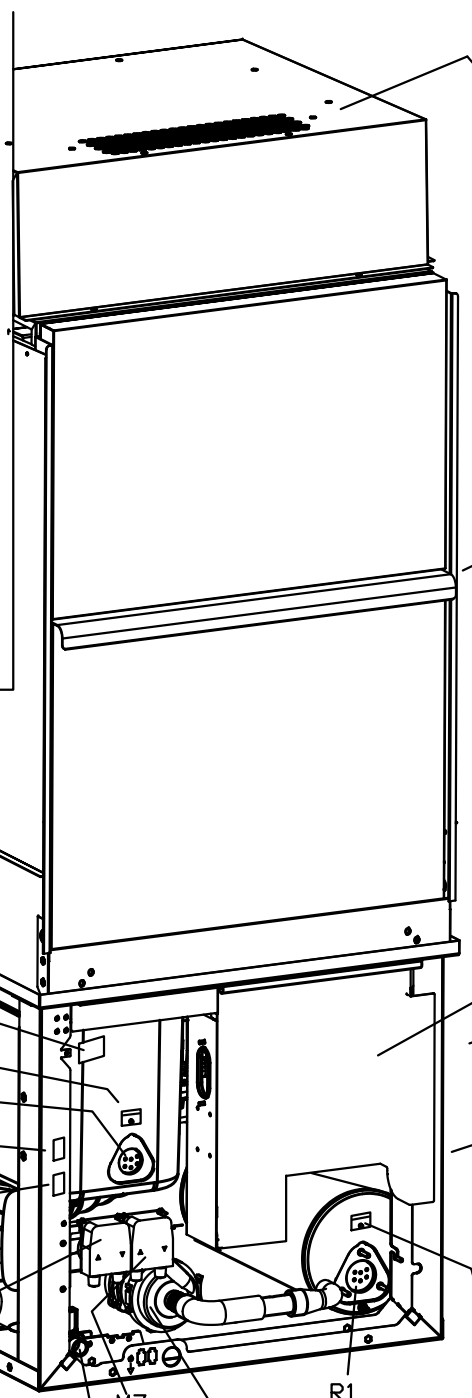
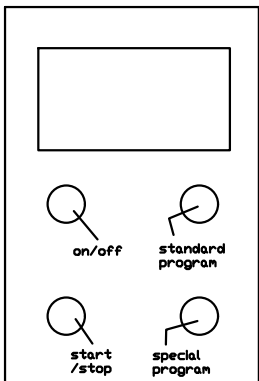

- B16
- E2
- R3
- F1
- F3
- M6
- M5

- Y1
- M7
- M3
- R1

SOSTITUISCE DATA

code Machine		denomination		Codice	
re-examined	date/date	WIRING DIAGRAMM		82178	
	05/04/18				
inspected by	date/date	Dishwashers		n°/file	mod
validated by	date/date	total blat	N° blat	Next blat	82178L -
		5	2	3	

DESCRIZIONE

WIRING DIAGRAMM

Dishwashers

M9	VENTOLA CONDENSA VAPORI STEAM CONDENSOR FAN	VENTILATEUR DE CONDENSEUR DE VAPEUR DAMPFKONDENSATORLUFTER	
S5	MICROINTERRUTTORE MAGNETICO MAGNETIC SAFETY MICROSWITCH	MICROINTERRUPTEUR MAGNETIQUE MAGNETISCHER SICHERHITSSCHALTER	
F1	TERMOSTATO SICUREZZA BOILER SAFETY BOOSTER HEATER THERMOSTAT	THERMOSTAT DE SICURITE DU BOYLER SICHERHEITZUNG	
F3	TERMOSTATO SICUREZZA VASCA SAFETY TANK HEATER THERMOSTAT	THERMOSTAT DE SICURITE CUVE SICHERHEITS- TANKTHERMOSTAT	
R3	RESISTENZA VASCA LAVAGGIO WASH TANK HEATING ELEMENT	RESISTANCE CUVE DE LAVAGE WASCHTANKHEIZUNG	
R1	RESISTENZA BOILER BOOSTER HEATER HEATING ELEMENT	RESISTANCE BOYLER BOILERHEIZUNG	
M5	ELETTRODOSATORE TENSIOATTIVO EL. RINSE/ AID INJECTOR	DOSEUR EL. PRODUIT RINCAGE NACHSPUELMITTELDOSIERGERAET	
M6	ELETTROPOMPA DI SCARICO DRAIN PUMP	MOTEUR POMPE VIDANGE MOTOR LAUGENPUMPE	
M3	ELETTROPOMPA AUMENTO PRESSIONE RINSE BOOSTER PUMP	ELECTROPOMPE AUGMENT PRESSION DRUCKSTEIGERUNGSPUMPE	
M7/M8	ELETTRODOSATORE DETERSIVO EL. DETERGENT INJECTOR	DOSEUR EL. DETERGENT SPUEL MITTELDOSIERGERAET	
M1	ELETTROPOMPA LAVAGGIO WASH ELECTRIC PUMP	ELECTROPOMPE LAVAGE ELEKTRISCHE UMAELZPUMPE	
KR3	TELERUTTORE SICUREZZA LINEA SAFETY /LINE CONTACTOR	CONTACTEUR DE SECURITE DE LIGNE NETZSICHERHEITSSCHUTZ	
KR4	TELERUTTORE RESISTENZA VASCA TANK HEATER CONTACTOR	CONTACTEUR RESISTANCE BOYLER LUFTSCHUETZ F. BOILERHEIZUNG	
KR2	TELERUTTORE RESISTENZA BOILER BOOSTER HEATER CONTACTOR	CONTACTEUR RESISTANCE BOYLER LUFTSCHUETZ F. BOILERHEIZUNG	
KM1	TELERUTTORE ELETTROPOMPA LAVAGGIO WASCH PUMP CONTACTEUR	CONTACTEUR ELECTROPOMPE LAVAGE SCHUETZ F. UMWAEHPUMPE	
Y1	ELETTROVALVOLA CARICAMENTO FILL SOLENOID VALVE	ELECTROVANNE DE RINCAGE MAGNETVENT FUER NACHSPUELUNG	
B19	PRESSOSTATO LIVELLO DI SICUREZZA SAFETY LEVEL PRESSOSTAT	PRESSOSTAT DE NIVEAU DE SECURITE SICHERHEITSNIVEAU DRUCKSCHALTER	
E2	SONDA CONTROLLO VASCA PROBE TANK HEATER	THERMOSTAT RESISTANCE CUVE TANKHEIZUNG/THERMOSTAT	
E1	SONDA CONTROLLO BOILER BOOSTER HEATER THERMOSTAT	THERMOSTAT RESISTANCE BOYLER BOILERHEIZUNG	
C1	CONDENSATORE CAPACITOUR	CONDENSEUR KONDENSATOR	
B10	PRESSOSTATO LIVELLO BOILER BOILER PRESSURE SWITCH	PRESSOSTAT NIVEAU SURCHAUFFER NACHSPULBOILER NIVEAUSCHALTER	
B18	CONTROLLO LIVELLO BRILLANTANTE RINSE AID CONTROL LEVEL	CONTROLE NIVEAU PRODUIT DE RINCAGE STUFE GLANZMITTEL	
B12	CONTROLLO LIVELLO DETERGENTE DETERGENT LEVEL	CONTROLE NIVEAU DETERGENT SPULMITTELNIVEAUSCHALTER	
B16	PRESSOSTATO LIVELLO VASCA TANK PRESSURE SWITCH	PRESSOSTAT NIVEAU AIRGAP TANKDRUCKSCHALTER-NIVEAUREGLER	
A1/A2/A3	SCHEDA CONTROLLO ELECTRONIC CONTROL UNIT	FICHE DE CONTROLEELECTRONIQUE ELEKTRONISCHE BEDIENUNGSKARTE	
F5	FUSIBILE FUSE	FUSIBLE SICHERUNG	
SIMB.	DESCRIZIONE DESCRIPTION	DESCRIPTION BESCHREIBUNG	

code Machine		denomination			Code	
re-examined		WIRING DIAGRAMM			82178	
date		05/04/18				
inspected by		Dishwashers			n°/file mod	
date						
validated by		total blat 5 N° blat 3 Next blat -4			82178 --	

DESCRIZIONE	SOSTITUISCE	DATA
-3		
-2		

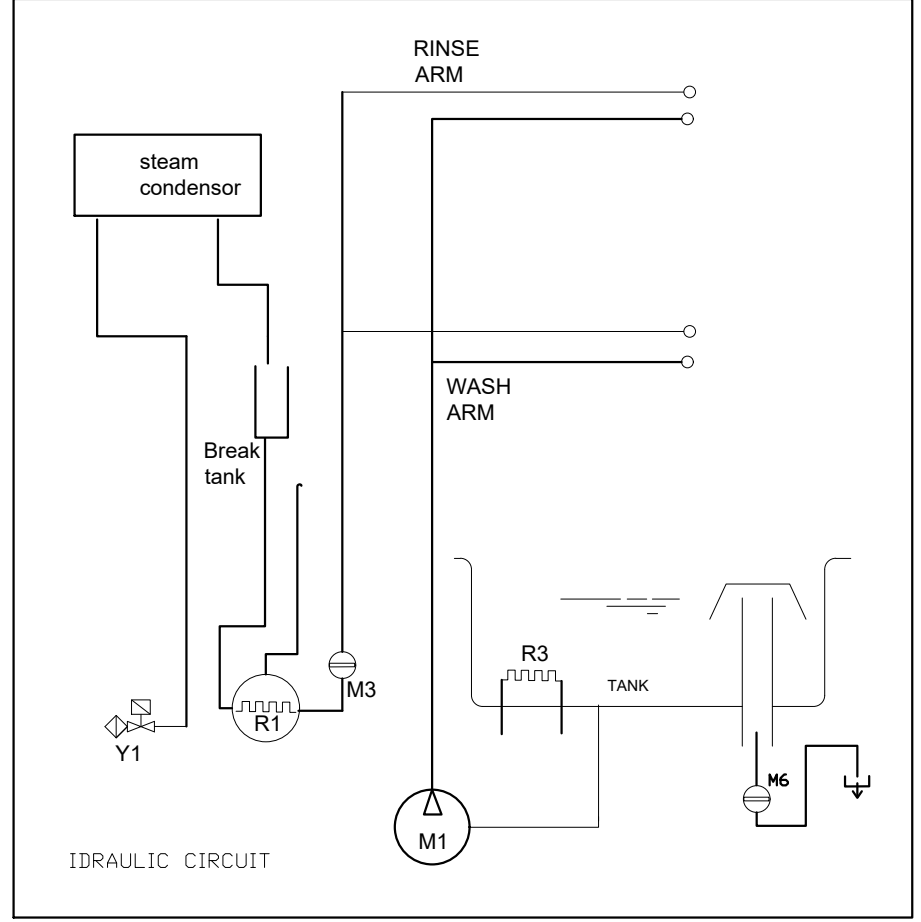
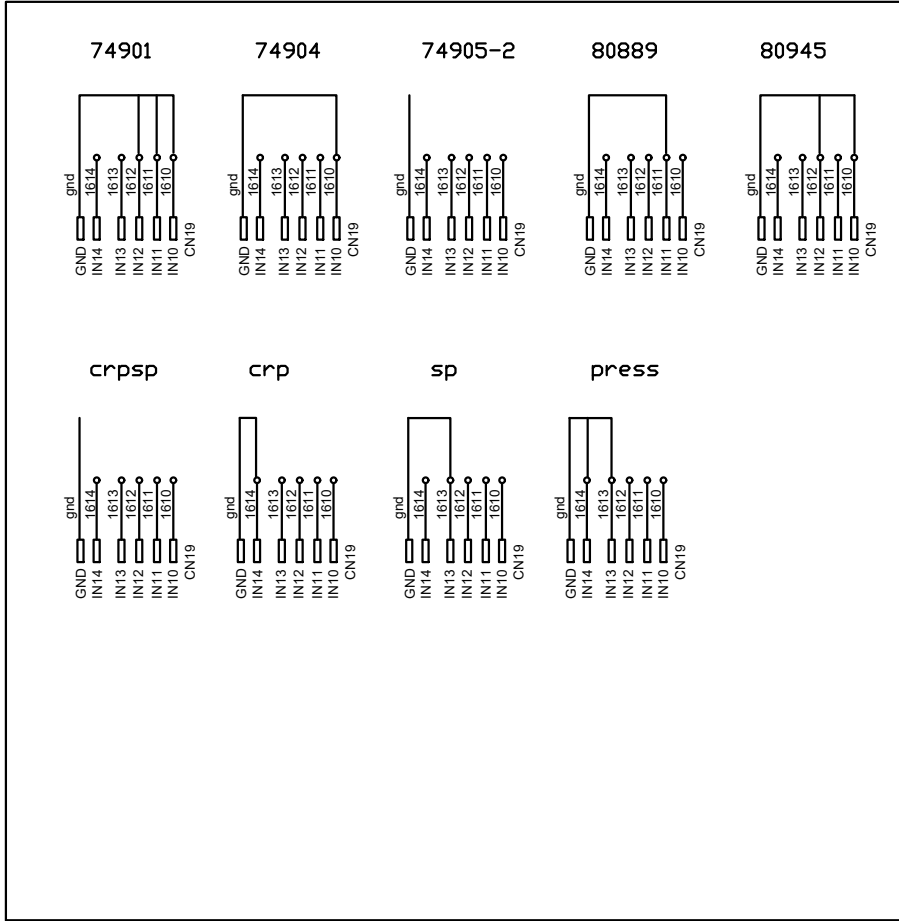

DESCRIZIONE	SOSTITUISCE	DATA

code Machine		denomination			Codice	
re-examined	date/date	WIRING DIAGRAMM			82178	
	05/04/18					
inspected by	date/date	Dishwashers			n°/file	mod
validated by	date/date	total blatt	N° blatt	Next blatt	82178I---	
		5	4	5		

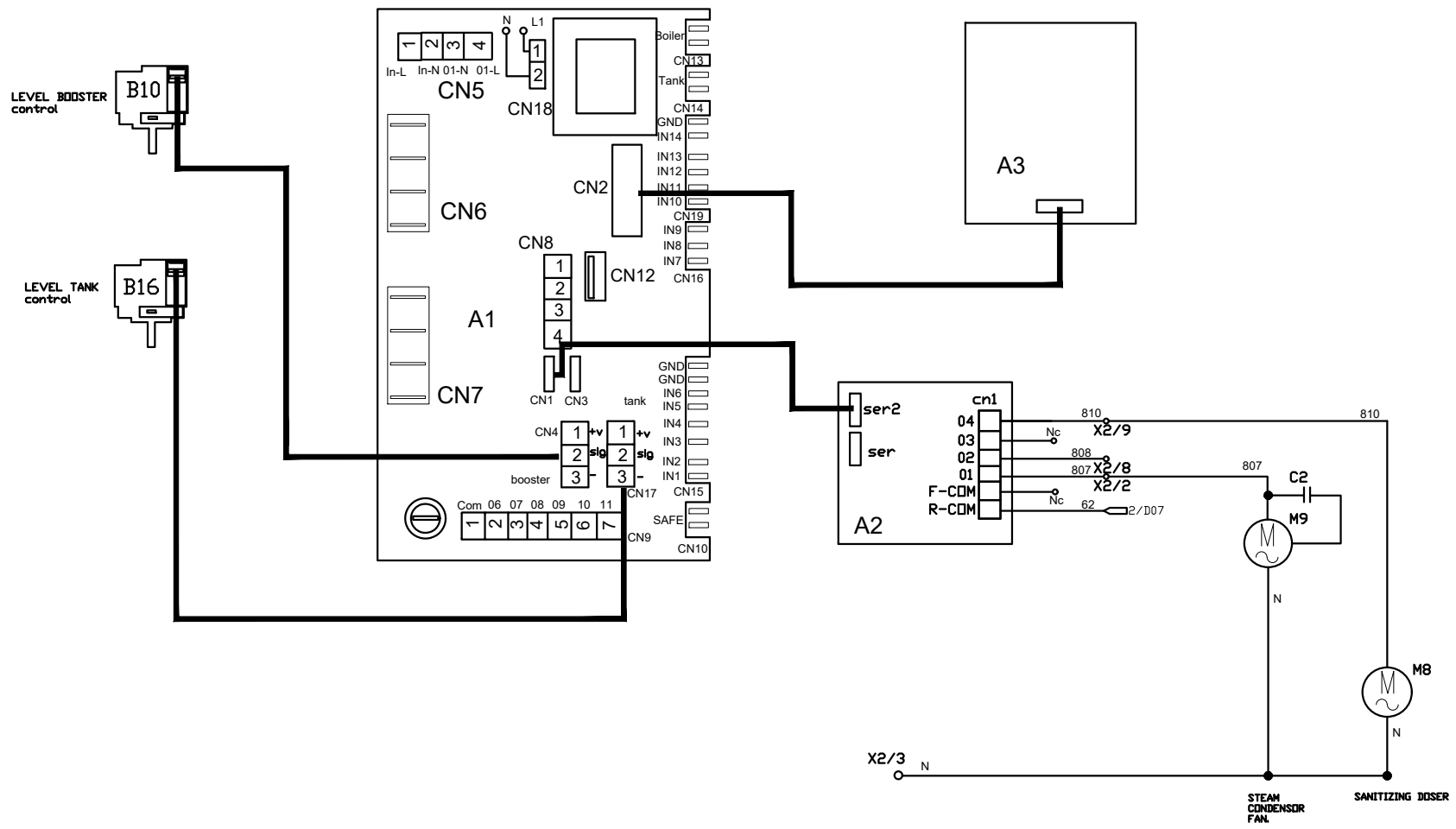

OPTIONAL

DESCRIZIONE	SOSTITUISCE	DATA
-3		
-2		

code Machine		denomination			Codice	
re-examined	date/date	WIRING DIAGRAMM			82178	
05/04/18						
inspected by	date	Dishwashers			n°/file	mod
validated by	date/date	total blat	N° blat	Next blat	82178	--
		5	5			